



Bello 2 mini / Eet- en werkstoel



Aanvrager / Dealer:

Besteldatum:

Adres:

Ordernummer:

Postcode / Plaats:

Referentie:

Contactpersoon:

Telefoonnummer:



De Bello 2 mini biedt zelfs de allerkleinste kinderen extra ondersteuning tijdens het zitten. Het grote bereik van het onderstel maakt de stoel eenvoudig in hoogte verstelbaar van grond tot tafelhoogte.

Standaard uitvoering voorzien van:

- Bekleding uitgevoerd in stof
- Zithoek, -hoogte, -diepte en -breedteverstelling
- Rughoek en -hoogteverstelling
- Voetenplank in hoogte, kniehoek en enkelhoek verstelbaar
- Armsteunen in hoek, breedte en hoogte verstelbaar
- Bevestigingspunten voor positioneringsmaterialen
- 4 dubbel beremde zwenkwielen
- Duwbeugel

Maten - Uitvoeringen

	mini
A Zitdiepte	12 - 19 cm
B Zitbreedte	14 - 22 cm
C Rughoogte korte rugleuning	28 - 33 cm
Rughoogte lange rugleuning	30 - 35 cm
D Zithoogte gasveer	25 - 62 cm
E Onderbeenlengte	12 - 22 cm
F Breedte totaal	52 cm
G Lengte totaal	58 cm
Zithoek	0° - 42° / -5° - +37°
Rughoek	-5° - +25°
Gewicht	16 kg
Maximale belasting	20 kg

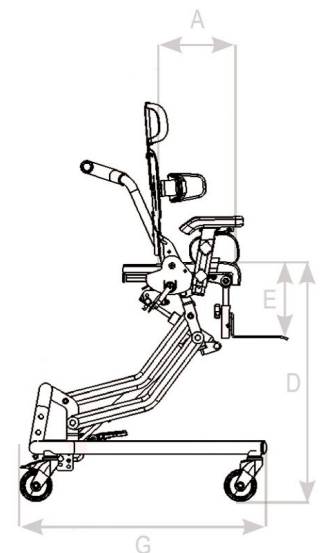
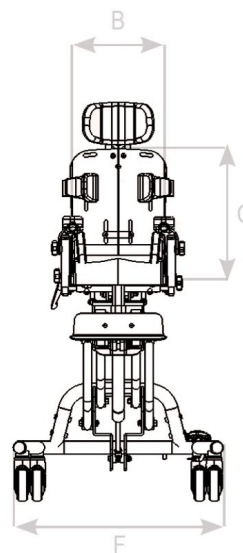



Bello 2 mini / Eet- en werkstoel



Uitvoeringen

	Bestelcode	Omschrijving	Bruto Excl.	BTW
	SC-3100000/NL	Bello 2 mini	€ 3.209,00	H



Zithoekverkanteling

	Bestelcode	Omschrijving	Bruto Excl.	BTW
	SC-3100101	Zithoekverkanteling 0° - 42°	STD	
	SC-3100001	Zithoekverkanteling -5° - +37°	GMP	

Bekleding

	Bestelcode	Omschrijving	Bruto Excl.	BTW
	SC-9100219	Bekleding roze	GMP	
	SC-9100220	Bekleding blauw	GMP	

Hoofdsteun

	Bestelcode	Omschrijving	Bruto Excl.	BTW
	SC-3100021	Vlakke hoofdsteun, in hoogte en hoek verstelbaar	€ 295,00	H
	SC-3100124	Gebogen hoofdsteun, in hoogte en hoek verstelbaar	€ 416,00	H

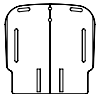
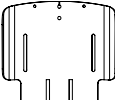

Rugleuning

	Bestelcode	Omschrijving	Bruto Excl.	BTW
	SC-3100002	Korte rugleuning, verstelbaar 28 - 33 cm	STD	
	SC-3100003	Lange rugleuning, verstelbaar 30 - 35 cm	GMP	
	SC-3100005	Korte rugleuning met bovenarmmonstersteuning, verstelbaar 28 - 33 cm	€ 56,00	H
	SC-3100006	Lange rugleuning met bovenarmmonstersteuning, verstelbaar 30 - 35 cm	€ 56,00	H

Rompondersteuning

	Bestelcode	Omschrijving	Bruto Excl.	BTW
	SC-3100009	Romppelotten, 7 x 9 cm (hxd), borstbreedte 14 - 20 cm	€ 124,00	H

Zitting

	Bestelcode	Omschrijving	Bruto Excl.	BTW
	SC-3100011	Standaard zitting	STD	
	SC-3100014	Zitkussen voorzien van incontinentie bestendige coating	€ 215,00	H



Bello 2 mini / Eet- en werkstoel

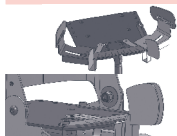

Zitopties

	Bestelcode	Omschrijving	Bruto Excl.	BTW
	SC-3100013	Abductie instelling 0° - 30°, incl. polstering en een 10 cm bredere voetenplank	€ 367,00	H
	SC-3100015	Binnenbeensteun, abduceerbaar, incl. zitkussen	€ 237,00	H





Dijbeenondersteuning

	Bestelcode	Omschrijving	Bruto Excl.	BTW
	SC-3100016	Dijbeenondersteuning kort 13 cm	€ 222,00	H
	SC-3100017	Dijbeenondersteuning lang 16 cm	€ 222,00	H

Werkblad

	Bestelcode	Omschrijving	Bruto Excl.	BTW
	SC-3100022	Werkblad met rand, wegneembaar	€ 289,00	H

Positioneringsmateriaal

	Bestelcode	Omschrijving	Bruto Excl.	BTW
	AK-001202	Bekken/borstband maat 0	€ 117,00	H
	AK-001204	Vierpuntsgordel maat 0	€ 144,00	H
	AK-000065	Zitbroek maat 0	€ 183,00	H
	AK-001205	Flexibel positioneringsvestje maat 0	€ 190,00	H